

0 603 296 703

Stand 16
Issue 02-08-01

Fig./Abb. 3

Pos 80 Alt / Old
Ancien / Vieja

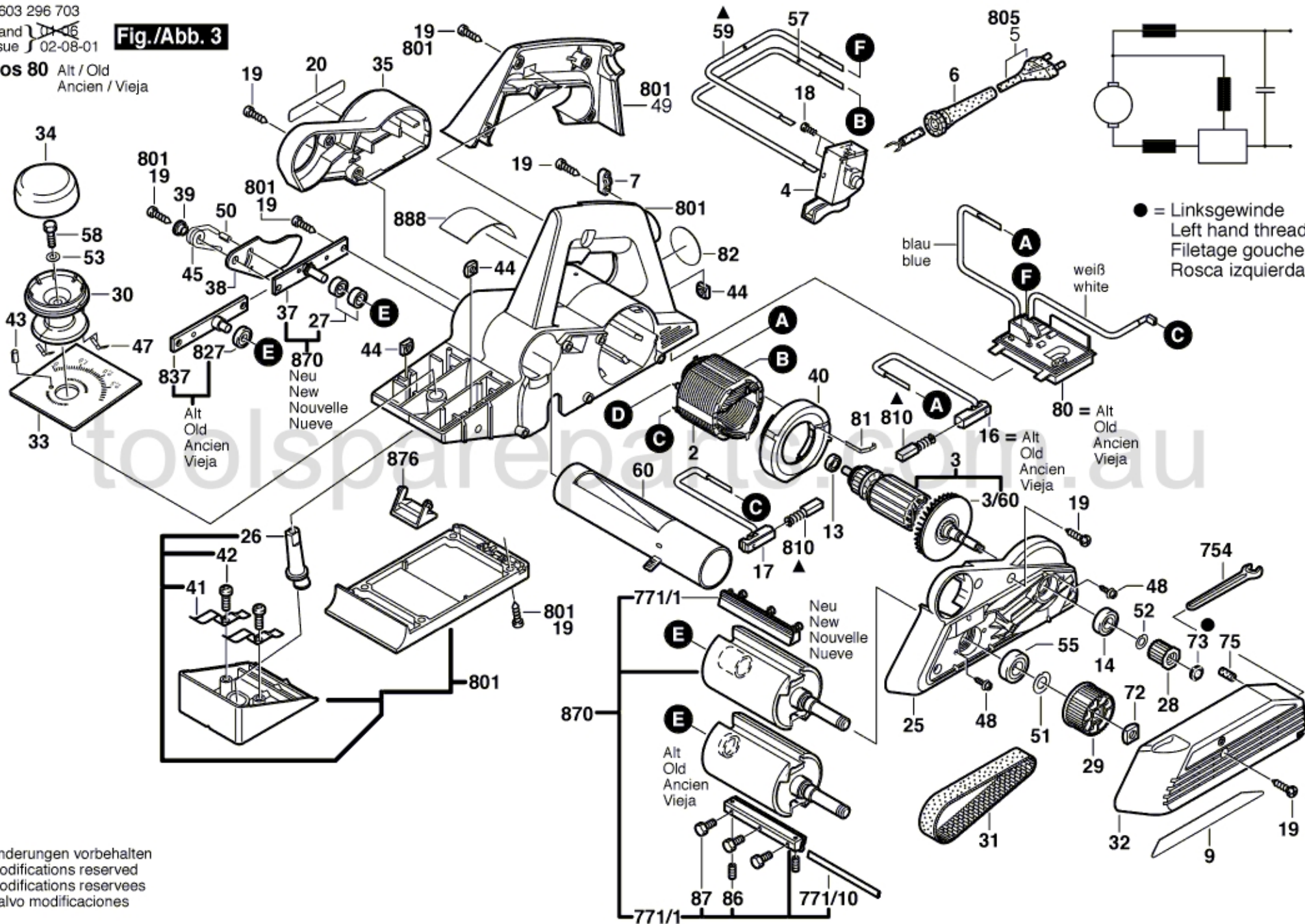

Änderungen vorbehalten
Modifications reserved
Modifications reserves
Salvo modificaciones